

# User manual and Installation Guide

## AHU-200 KV SLIM AHU-200 KH SLIM



ErP 2018





## User manual. Pages 2 til 15

(On pages, 2 - 6 the pictures shows AHU-200 KV SLIM)



Be careful that the door can "be stuck" in the sealing on the hatch.  
For easier loosening of the hatch, release it first in one corner at the top.



To operate this product people should have necessary skills, or under the supervision of a qualified person.



Tell children not to play with the appliance.

If you are going into the unit then you first have to remove any kitchen furniture front door, if so is mounted on front of unit.

On these pictures, you can see the ventilation unit with white coated cooker hood.  
There are also variants with hoods in brushed stainless steel.

To open the front hatch you first have to untighten those four screws you find in each corner of the unit.



When hatch is to be mounted back on the unit try to use almost same torque on all four screws.

Then put the kitchen furniture front door back on place.



Before any access into the electrical connections boxes, power must be disconnected by pulling out the plug from the socket.



Only authorized persons is allowed to enter into the electrical connection boxes.

If any electrical components are damaged, they must be replaced by the manufacturer, dealer or a qualified person in order to avoid dangerous situations.



### Adjustment of the unit.

A humidity sensor is, from factory, mounted inside the unit. It is set to "0" that means it is set to not active.



After startup, where the unit is placed into a new building with high humidity, you can let this humidity sensor be turned off for a period to avoid the full speed of the fan at night. To get the humidity sensor to operate as intended, you need at one time to put it active. Than you need to set the switch in position "1".

If the ventilation unit is placed in a house without high humidity, you should switch to position "1" after you putting ventilation unit into operation. **This switch will also affect any extra external humidity sensor that is plugged into the device.**

### Adjusting the humidity sensor.

If it is necessary to adjust the sensitivity of the humidity sensor then you just can remove the black plug and you then can see the adjusting knob and the RH% scale.

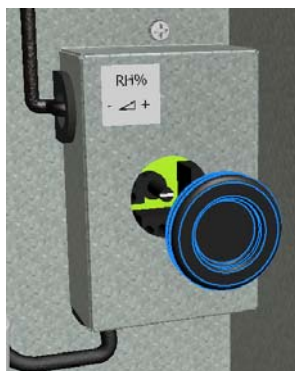

If a need for better insight or do not see the adjustment scale sufficient so one should remove the entire cover of this control board.



**The sensor is set to 80% RH from factory.**



If you do adjustments, this only affect the sensor integrated inside the unit.

The sensitivity for the integrated sensor you can adjust from 50% (low) to 90% (high) in accordance to what are the need. The arrow points the value chosen.

If you have a second external sensor that means you need to adjust that one from its settings.

Replace the cover and / or plug after finish adjusting.

**Replacing the filter.**

The filters should be replaced every 6. 9. or 12. months.

Should be extracted without use of any tools.

Remember to enter the control panel menu (4.3 Filter) and press **Filter OK** after the filters has been replaced.

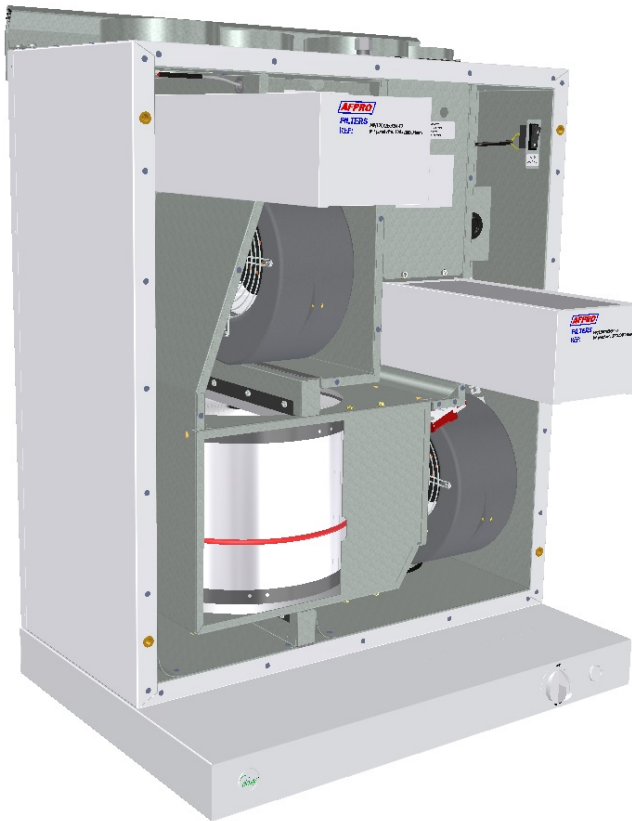

*To guarantee optimal properties of the ventilation unit, use the original filters from EnSy. The use of spurious filters will limit the warranty on the product.*

**Ensy art number for filter set is:**

011460850-2

SET FILTRE ENSY AHU 200 + 300 B. F7: 120x280x94



### **Cleaning the fans.**

This must be done by a qualified person.

Before removing fans the main power must be disconnected by pulling out the main supply plug from the socket, or fans to be programmed to position "AV" or "OFF"

Disconnect the 3-pole and 5-pole plugs.

The fans can be pulled out of the ventilation unit without the need for any tools.

Clean with mild soap and water



### **Maintenance and cleaning of rotary heat exchanger.**

This must be done by a qualified person.

Disconnect the 3-pole plug.

Can be pulled out of the ventilation unit without the need for any tools.

To not scratch the cooker hood so you should cover this before you pull out the rotary heat exchanger.



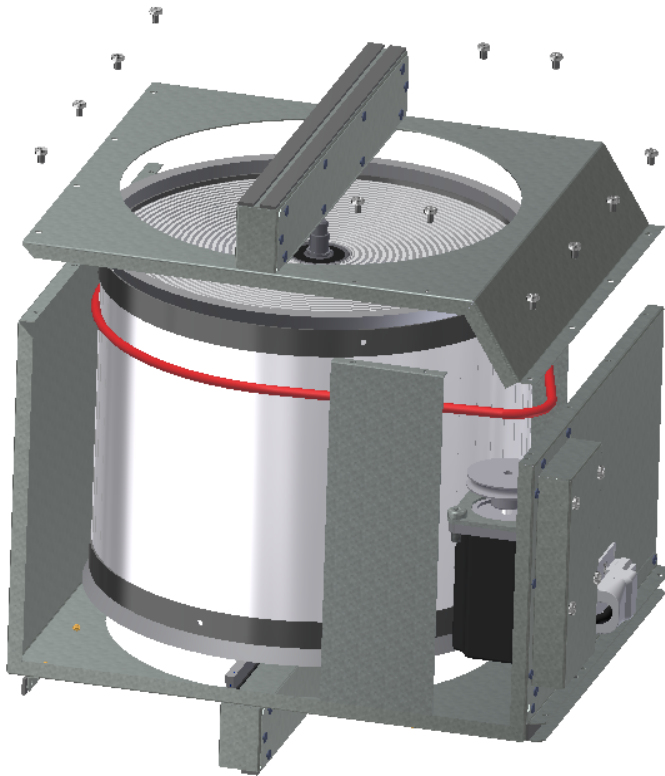

Rotor exchanger can easily be removed for cleaning by dissolving the 12 screws that hold it together.

Clean parts with mild soap and water



Do not expose the rotor motor or connector for moisture.



The exchanger you also can clean with mild soap and water. Do not use ammonia-containing detergent, as this will prey on and discolor aluminum in rotary heat exchanger. Flushed with hand shower and blow gently clean with compressed air.

Ensure that the screws are tightened sufficiently so that they do not come loose during operation.

Preferably use a screwdriver to tight the screws. If use of electrical screwdriver, make sure that you use low torque to prevent destroying the threads in the sheet metal parts.

To make sure that the drive belt can adjust itself into correct position you must rotate the exchanger some few turns.

Then insert back into the ventilation unit. Be sure that rotor exchanger is properly inserted in all the guides inside the unit. If not, this can lead to vibration in the system and internal air leak in the unit.

## Operation of kitchen hood

ON / OFF switch for down lights.



Using the damper in a kitchen hood.

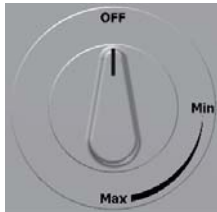

No function

The switch has a spring retraction and will not work until it has passed "Min"

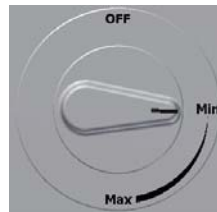

Opens damper.  
Timer activated

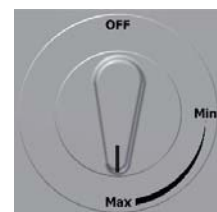

Max time on timer  
60 min

## Replacing the lamp and transformer on the cooker hood

Turn off the power before replacing the down light.

If the light is not working then you must replace the entire light socket and transformer. To replace the user must first remove the four blanking plugs and then loosen four screws to release the entire cover.

Compress the spring with fingers to more easily sliding light socket out through cover.

The plugs that is between light and transformer can be pulled apart.





**If faulty light then both downlight and transformer replaced with new parts.**

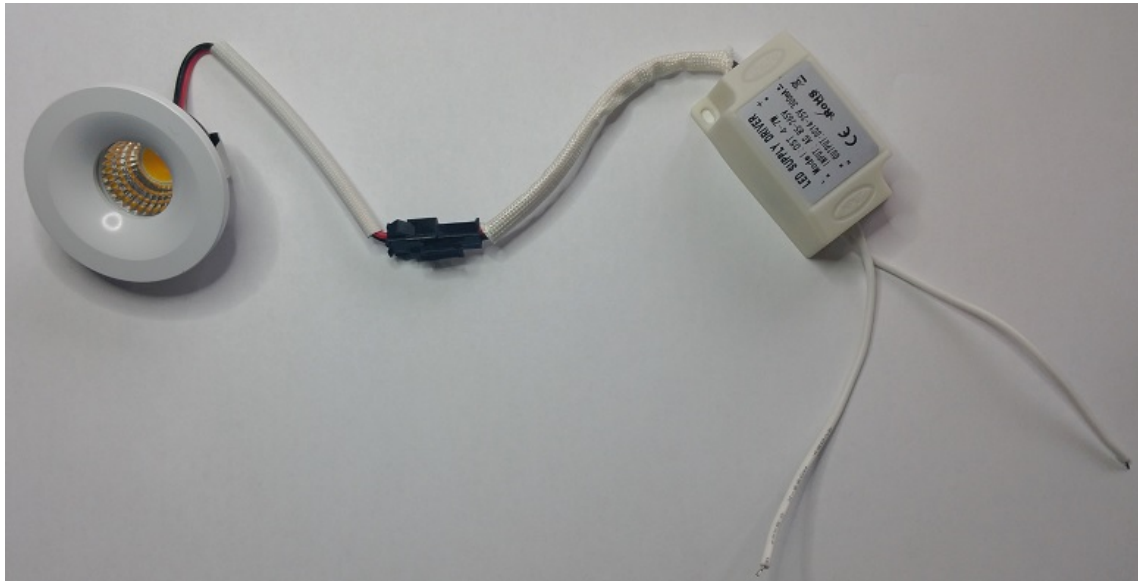

### **Original LED light that is inserted from factory**



Ensy art no:

**260455-2 Down Light LED 5W with white socket and transformer**

**260456-2 Down light LED 5W with black socket and transformer**

### **Replacement or washing the filter in the kitchen hood.**

Release from the frame by pushing the lock to the middle of the filter and tilted down. The filter can be washed in soapy water. Must be completely dry before it is mounted in place again. If the filter material is damaged it must be ordered new original.



**(Ensy art no: 270081-2)**

**Main menu**



1. Control Button indicator for fan.
2. Control Button indicator set point.
3. Control Button indicator information.
4. Control Button indicator settings.

**Overview of control panel**

The main screen consists of, from top, left:

- Time Indication, hour, minute
- Timer, Weekly schedule (if programmed)
- Reheating coil (if connected)
- Temperature readings, Outdoor / Indoor
- Status airflow – fan speed setting  
OFF MIN NORM or MAX
- Temperature set point, 15 - 21 °C
- Reheating coil – (here refers active element)
- Rotary exchanger Indicator - (here refers active rotary wheel)

**Indicators in the menu screen:**



"Sun" indicates that the rotor has stopped, the air handling unit is in the summer operation mode.



"Snowflake" low temperature indicates that the air handling unit is in defrosting mode.



"Steaming pot" and blinking fan blades indicates that the kitchen exhaust is activated.



"Timer" and the countdown of the fan symbol indicate that the forced ventilation is enabled. From 10 up to 240 minutes



"Away" indicates when the feature is enabled, this feature will override timer.



"Clock over the fan symbol" indicates that the timer is activated.

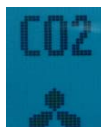

Co2 over the fan symbol" indicates that the carbon sensor is activated.



"Exclamation point" indicates that moisture recorded over the sensor is higher than the set value. May also indicate that the motion sensor is activated if connected on D2 signal output.



This symbol indicates that the rotary heat exchanger is activated and will be rotated.

### 1. Fan speed

Ventilation unit has three options for choice of airflow.



Min, Normal and Max.

For programming of values within each step, see 4.5.1.3 Using the control button 1, and - / + buttons can change between the pre-programmed selections.



#### 1.1 Fan boost

Forced ventilation, fan speed increases to max speed. (Means to the speed that is set in menu 4.5.1.3.) The function is for use if high humidity in bathrooms and laundry room.

Forced ventilation can be activated with button



Interval adjustable from 10 - 240 min with + and -



This picture shows 10 min forcing time, but not activated.

To activate the fan boost use control button 4.



You can see that the fan are running with Max speed and the clock will start countdown. You can easy deactivate the fan boost again before the countdown automatically stops it.

First control button 1  and then 4. 

This feature can also be operated with an external pulse switch. The switch is placed in the bathroom or adjacent rooms. Connected to contact **D1** in top of the ventilation unit. (Look at page 23 in this manual.) If this option via **D1** is intended for use against **wood stove or fireplace** then it is recommended that Max speed under Fan control in menu 4.5.1.3. is set to Supply 100% and adjust Extract to be 80 to 85%. (Look at page 10 in this manual)

### 2. Temperature

Choose from pre-programmed temperature settings set point between 15 - 21 °C. Setting is changed by operating the switch buttons below - / + symbols.



Indicator for activated heating coil.  
Small picture show not activated.

Heating element can here be set ON or OFF by operating the switch button 4 in this screen, but only if heater is connected.

(To see if heating coil is connected or disconnected, see 4.5.1.1 Heater)

### 3. Information.



#### 3. Information / 3.1.Alarms



When alarm you can find a source of error here, as well as info on how the alarm is reset. (See pages 29 and 30 in this manual)

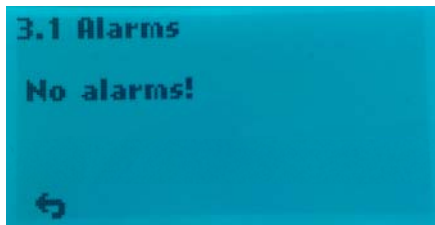

#### 3. Information / 3.2 Program version



Information about the software version. This information must be provided to service personnel at the failure of the unit.



### 3. Information / 3.3. General info

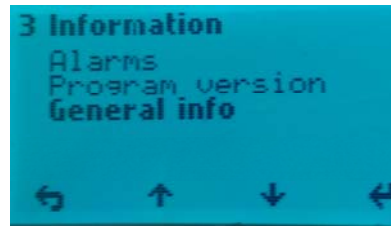

Here you can see defrost mode that has been chosen.

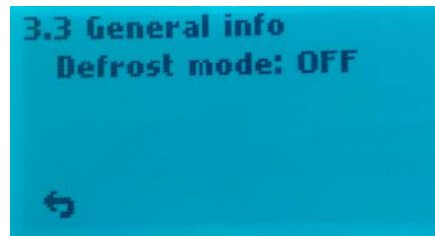

(See 4.5.1.9 if you want to change mode.)

### 4. Preferences

To navigate within the various sub-menus when using the control buttons below the up / down cursor key that displays on the display.

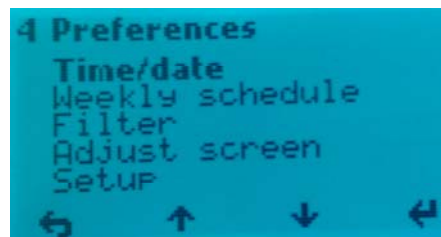

#### 4. Preferences / 4.1 Time/date

Setting menu for Time/date. This setting is important since the information forming the basis for the weekly schedule function if this is to be activated. Also for the filter alarm function it is needed.

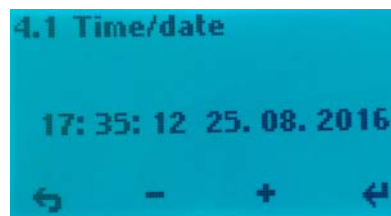

#### 4. Preferences / 4.2 Weekly schedule

Programming of the Weekly schedule, fan speed and temperature set point. Here it can be programmed for two periods each day. Ex. day - night.

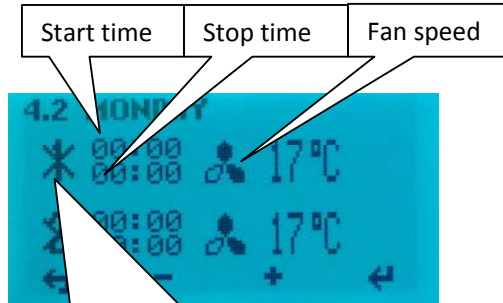

Activation of the period. Here not active

Every day must be programmed individually. Monday - a period of time, select the start time. To activate the period, X - over period number is removed, use the - / + keys.

 Use enter to move between the different fields.

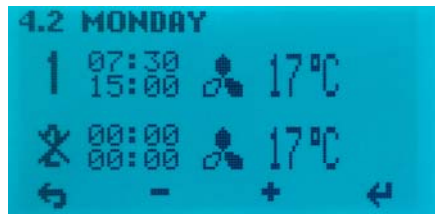

Choose airflow (fan speed) Speed dialing - **MIN** when one fan blade on the indicator is black. **NORM** = two black fan blades on the indicator. **MAX** speed = three black fan blades on the indicator.

Select the desired supply air temperature you want during the period. Settings between 15 - 21°C.

 If weekly schedule looks something like this without any reason then you must punch in all the data again.

**It do not help to update software.**



#### 4. Preferences / 4.3 Filter

Setting the time interval for filter change, current choices are 6, 9 or 12 months. Make your choices by using the cursor keys + / -.



Alarm reset elapsed period by pressing the menu button 4, under "Filter OK"

#### 4. Preferences / 4.4 Adjust Screen

Adjusting the contrast and color on the display.

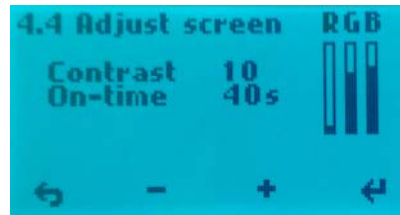

You can also adjust how long it should be light in the display after the operation.

#### 4. Preferences / 4.5 Setup

To proceed, use PIN code 1000



Press + once till it shows 1000 in  display. Then press 4 times on



Then press button 3 for OK 4.5.1

#### 4.5.1 Setup

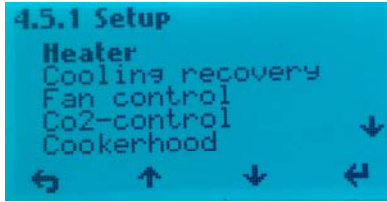

##### 4.5.1.1 Heater

Turning on/off the reheating coil, use the minus or plus button to change settings.



##### 4.5.1.2 Cooling recovery

Activation of the cooling recovery:

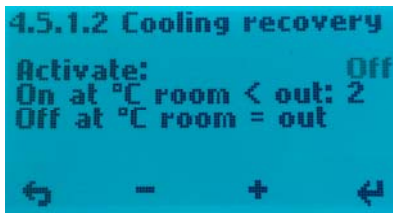

It is pre-programmed two options for use when the outside temperature is higher than the indoor temperature, heat recovery system will activate the function start and supply air will be cooled by exhaust air. Engagement when the outdoor temperature is 2 °C or 3 °C higher than room temperature. Use button 4 to change setting for Off. Press + to activate (On). Use button 4 to change setting for 2°C. Press + to change to 3°C, if wanted.

##### 4.5.1.3 Fan control

Factory settings for AHU-200 KV and KH SLIM you can see in next picture.

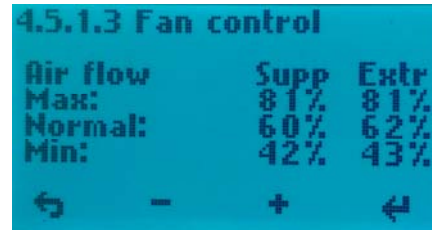

The installer can adjust these settings so that it is adequately balanced ventilation.

##### 4.5.1.4 Co2 control

If the unit shall be connected CO<sup>2</sup> control then connect it to CO<sup>2</sup> connector on top of the unit. (See page 24 in this manual).

Menu for enabling / disabling of CO<sup>2</sup> control.

Scroll to **Off** and press + to activate. **On**

Here you preprogrammed wanted ppm value and the boost speed for the fans.

**Note:** To get balanced ventilation is a prerequisite that Supply and Extract air fan has the same value as the MAX value under 4.5.1.3

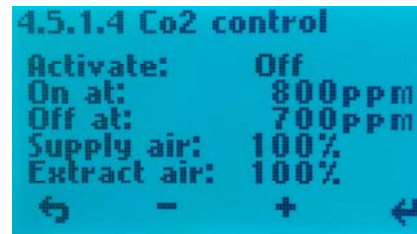



#### 4.5.1.5 Cooker hood

Menu for programming of fan speeds by activation of the kitchen hood.

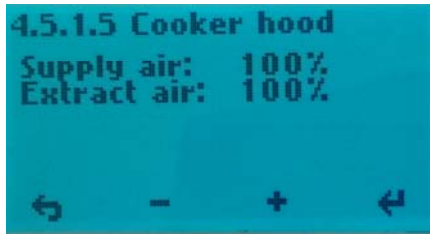

Supply and Extract air should have the same value as the MAX value under 4.5.1.3 (Set to 100% from factory.)

#### 4.5.1.6 Extern alarm

If the unit has been connected to an external humidity sensor or motion sensor. Use the **D2** connector on top of the unit. (See page 24 in this manual).

**Note!** In order for this feature to work, you need the one-pole switch marked RH% ON / OFF inside the unit to be set in position 1. (See page 3 in this manual for the location of this switch).

Supply and Extract air should have the same value as the MAX value under 4.5.1.3 (Set to 100% from factory.)

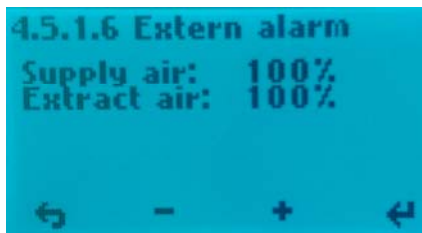

#### 4.5.1.7 Absent

Menu for setting the desired values by activating away / home function.

Use the **D3** connector on top of the unit. (See page 24 in this manual) Function is operated via an external switch.

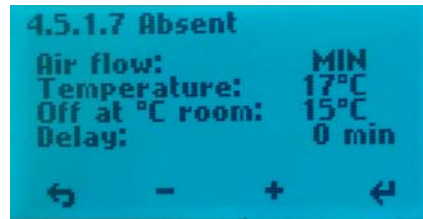

Set value of the desired temperature will show in the display after activating the function.



#### 4.5.1.8 Calibration

Menu reading of embedded temperature sensors.



These temperature sensors are delivered calibrated from the manufacturer and should not be attempted change in here.



The «Outside air» sensor normally shows 3-6°C higher temperature than the real outside temperature. This is due to heating of the air in the duct network from the intake grille to the intake of the unit where the sensor are placed.

#### 4.5.1.9 Defrost

Menu for how to change defrost mode if temperature is low and humidity is height.



From the start up menu you can see which defrost mode the unit is set in.

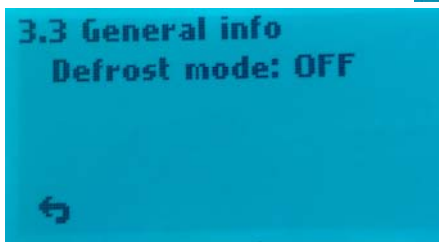

The unit is set in mode **OFF** from factory. If it is needed to change the defrost mode to another mode then press button 4 and scroll down to Configuration with button 3.

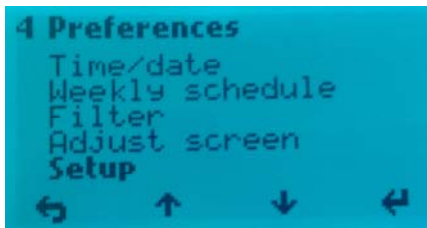

Press enter button and follow procedure as in **Menu 4.5 Setup** to continue.

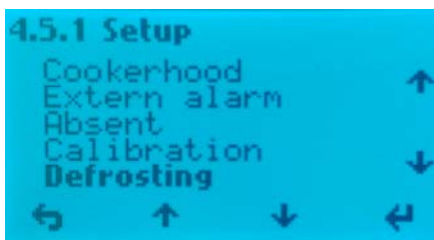

Press enter button

Defrost mode **OFF** from factory.



**Modus 1:** at low humidity. Defrosting function start at -20°C.

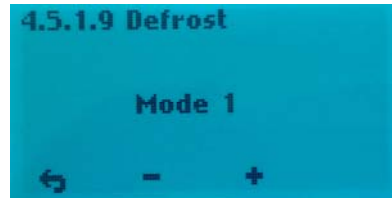

**Modus 2:** at normal humidity. Defrosting function start at -15°C.



**Modus 3:** at high humidity. Defrosting function start at -10°C.

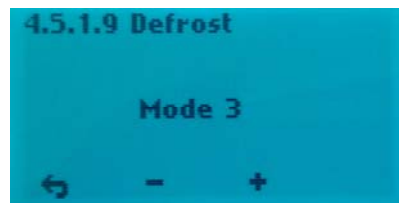

The function when defrosting starts is that each hour the supply air fan stops for 6 minutes. The heater **EV** turns off. Extract air fan reduces speed to 30% and the rotary exchanger will run as normal.

To avoid that the rotary exchanger will stop when the cycle goes back to normal function, the supply air fan will start up the last minute of the defrosting mode cycle.

(Supply air fan reacts delayed relative to the control signals and rotary exchanger so that the heater will not engage until the speed of the supply air fan has passed 250 r/min, in normal operation).

#### 4.5.1.10 Display number

On this unit it is only possible to connect one display.

From this menu it has to be specified that the control panels is «Display 1»



## Mounting instructions. Pages 17 to 28.

### Table of Contents

1. General
2. Mounting of the unit
  - 2.1 Brackets and gaskets to avoid vibration
  - 2.3 Duct cover
  - 2.4 Dimensions and technical data
3. Connections
  - 3.1 Electrical connections
  - 3.2 Duct connections

### 4. Setting the airflow

### 5. Alarms

#### 1. General

This guide is made to provide installation and user instructions regarding the correct installation of AHU-200 KV SLIM and AHU-200 KH SLIM.

AHU-200 KV and KH SLIM is designed for heat recovery with air volumes of up to 200 m<sup>3</sup> / h. The energy from the exhaust air is transferred to supply air through the rotary heat exchanger where the air streams pass each other without making contact.

The unit has a built in-heater for supplementary heating of supply air. Humidity sensor for forced ventilation is integrated into ventilation unit

The unit can also connect additional equipment. Pulse switch for controlling the forced ventilation, for example, wet rooms or bathrooms, sensor for carbon management and switch management away / home function. Control of these options are integrated into AHU 200-KV and KH.

AHU-200 KV and KH SLIM is supplied in painted finish, tested and ready for operation. Installation, commissioning and tuning must be performed by authorized personnel There are also variants with hoods in brushed stainless steel.

#### 2. Mounting

Together with the unit is delivered the following equipment:

1. Suspension bracket and stoppers
2. Wall Bracket with vibration dampening gasket
3. Self-adhesive vibration damping
4. Accessories bag containing the necessary screws
5. 4 pcs. plugs for connecting additional equipment.
6. Parts for mounting kitchen furniture front door.

#### 7. Control panel

First, select how the unit should be mounted so that the piping system should be as easy as possible.

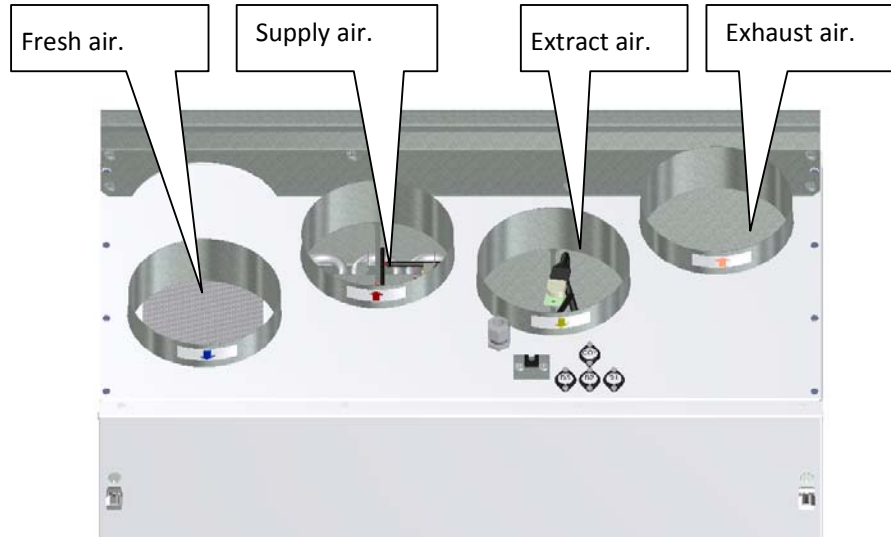

(Sketch over shows AHU-200 KV SLIM)

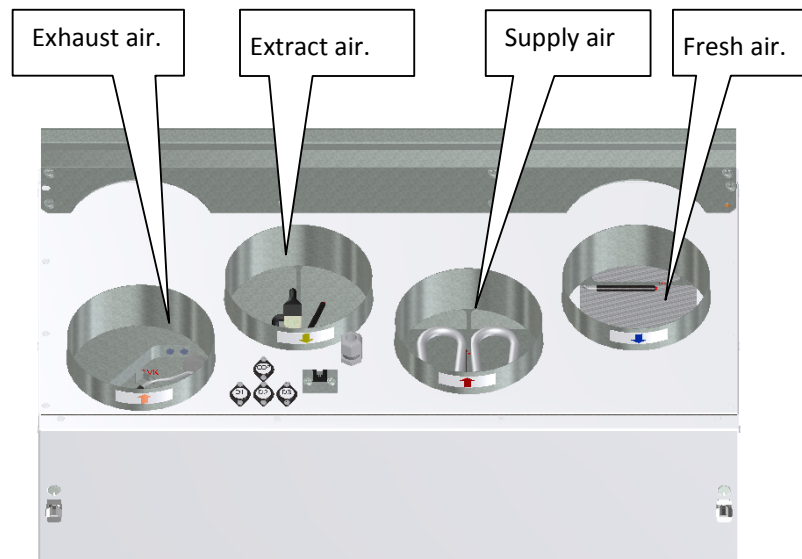

(Sketch over shows AHU-200 KH SLIM)

### 2.1 Brackets and vibration gasket

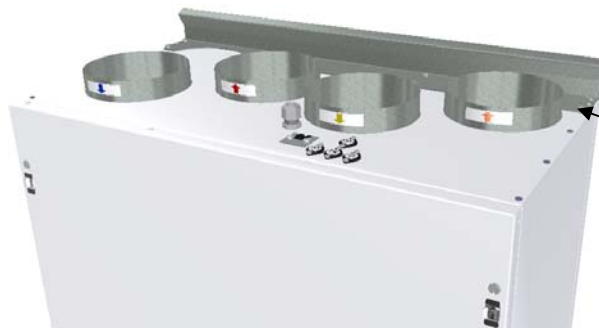

Suspension bracket screwed on top of the unit as shown.



Use 8 pcs M5 x 16mm, supplied with the unit.

(Sketch over show AHU-200 KV SLIM)

Mount the wall bracket with vibration gasket.

Make sure that the edge protection gasket is placed on the wall bracket.

Be sure that the vibration gasket is intact.

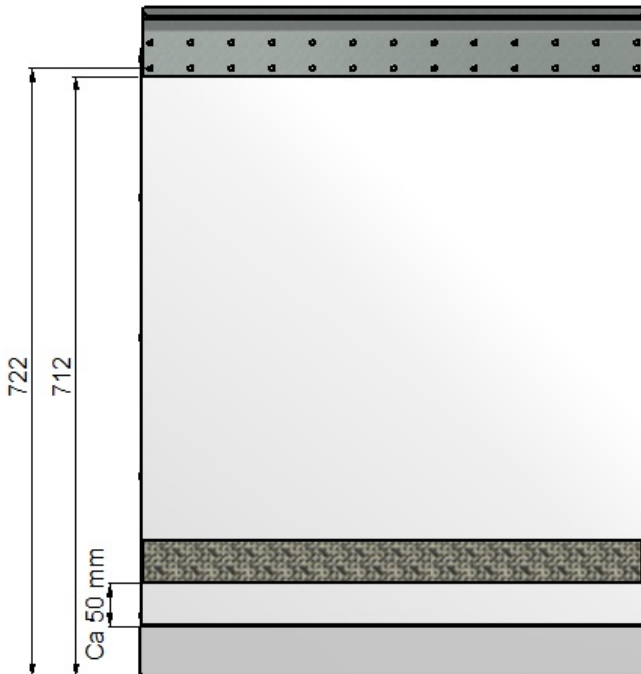

Glue vibration gasket to the back of the unit, see illustration. Approx. 50mm from the bottom of the unit.

Lift the unit in place and ensure that there is no direct contact between unit and building construction.



### 2.3 Duct cover

If you want to use a duct cover to hide the pipings you will need the distance 297 mm from the roof and down to the top of unit.

The duct cover has to be ordered separately from supplier. **(Ensy Art: 0100107-2).**

The instruction how to mount this duct cover you will find together with the duct cover.

*Instruction for mounting duct cover you also can find on web. [ensy.no/Products/Other products-accessories/Duct covers](http://ensy.no/Products/Other products-accessories/Duct covers).*

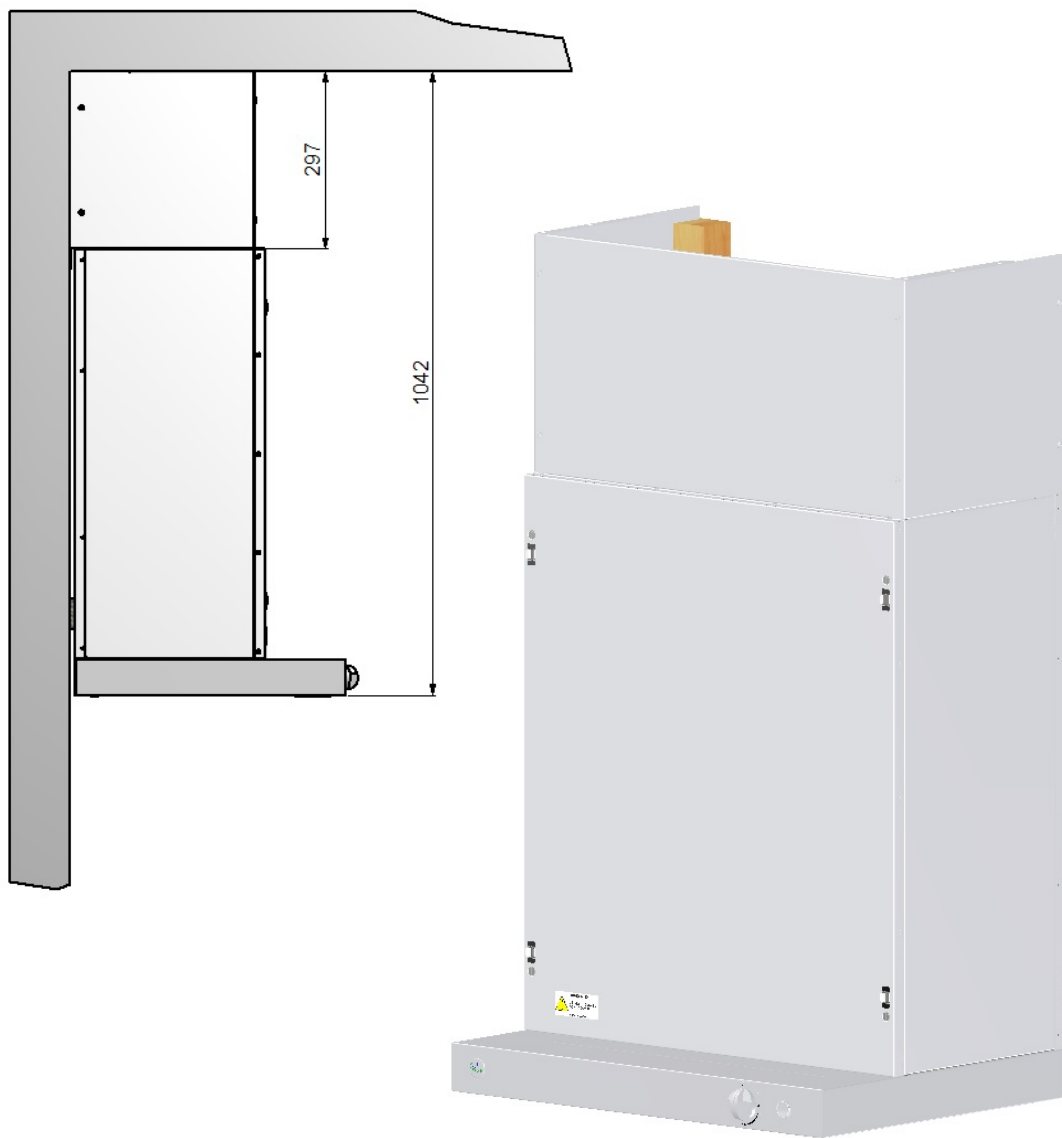

2.4 Dimensions

**AHU 200 KV SLIM**

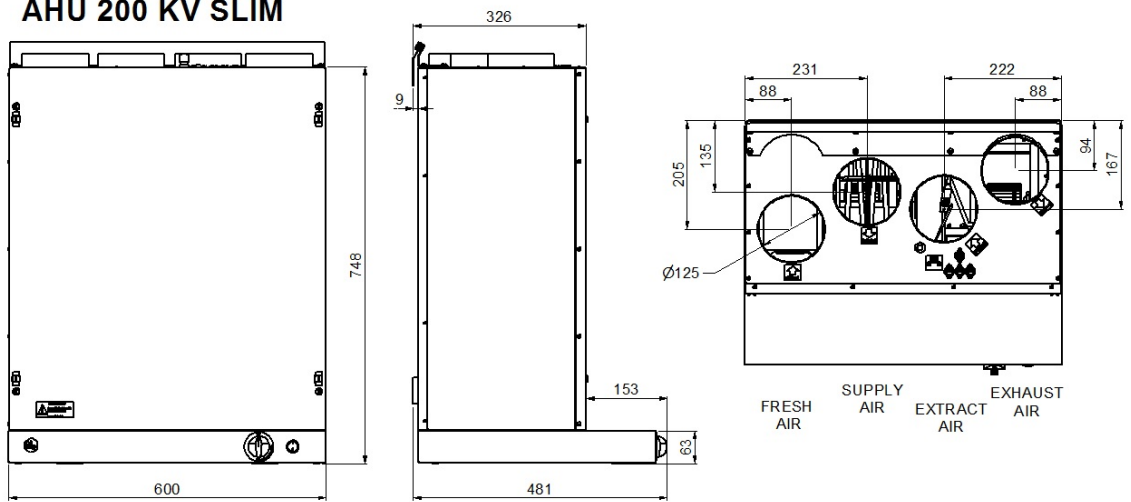

**AHU 200 KH SLIM**

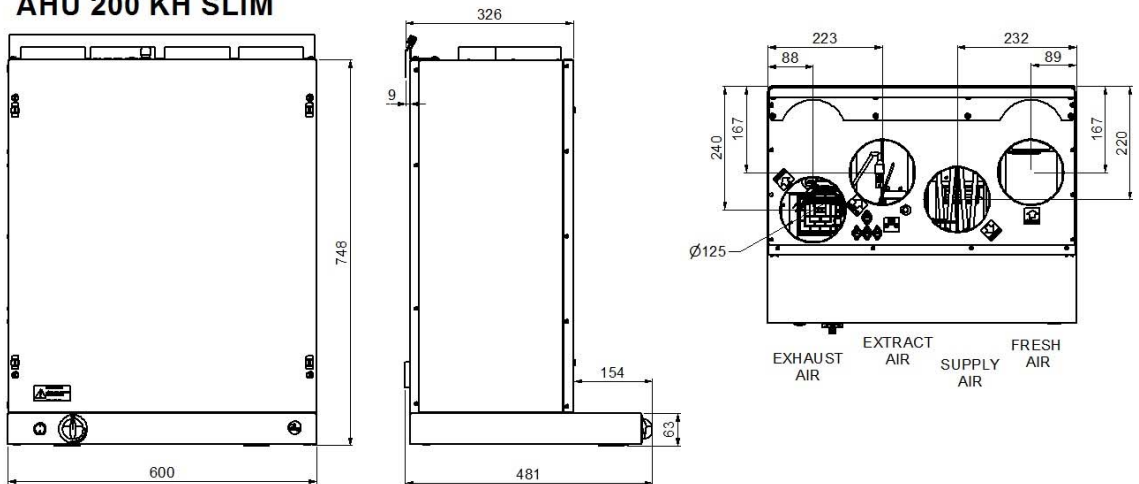

All ducts are  $\varnothing 125$  mm

## TECHNICAL DATA

Reheating unit + fans	- phase/voltage	(50Hz/VAC)	~1 / 230
	- power consumption	(W)	1200
Recommended fuses		(A)	10
Control system			Integrated
Filter Class	Superpleat		F7
IP class	Ventilation unit with closed front door		IP 4X
	Ventilation unit with open front door		IP 2X
Max W LED light in cooker hood			9 W
Thermal/sound insulation	(mm)		25
Wight, including brackets	(kg)		52

### SPECIFICATIONS:

- Rotary heat exchanger with heat recovery up to 85 % efficiency.
- Electric heating coil.
- High efficiency and low noise EC fans. Adjustable 30 to 100 % speed.
- Adjustable supply air temperature between 15 and 21°C.
- Acoustic and thermal-insulated housing.
- Integrated control system with "Touch Panel" for the control of the unit supplied as standard.
- Integrated cooker hood in bottom of the unit.

#### **In top of the unit there is:** (Look at page 24)

- Junction point of contact for connection for the control panel.
- Junction point of contact for Co<sup>2</sup> sensor. (CO<sup>2</sup>)
- Junction point of contact for pulse switch. (D1)
- Junction point of contact for an external humidity sensor or motion detector. (D2)
- Junction point of contact for connection for home / away function. (D3)

### ACCESSORIES:

Duct Cover for the encapsulation piping in the top. (Art. no: 0100107-2)

Wireless pulse switch. (Art. no: 0100052-2)

## Demand controlled ventilation - adequate air quality

<p><b>Control panel:</b></p> <p>The control panel to be placed at a suitable place in the building to do the monitoring and regulation of ventilation as simple as possible. Must not be placed in bathrooms or wet area.</p> <p>The control panel should be mounted on the wall.</p>	<p><b>Motion Detector:</b></p> <p>When installed in a living room, this will give the signal to the unit to increase speed to max airflow.</p>	<p><b>CO<sup>2</sup> sensor:</b></p> <p>Can be installed in the living room and will give signal to the unit if the pollution level in the room is too high.</p>	<p><b>Humidity sensor:</b></p> <p>Humidity sensor for forced ventilation is integrated into ventilation unit.</p> <p>Plug for extra sensor is placed on top of unit (D2)</p>
---	--	--	--

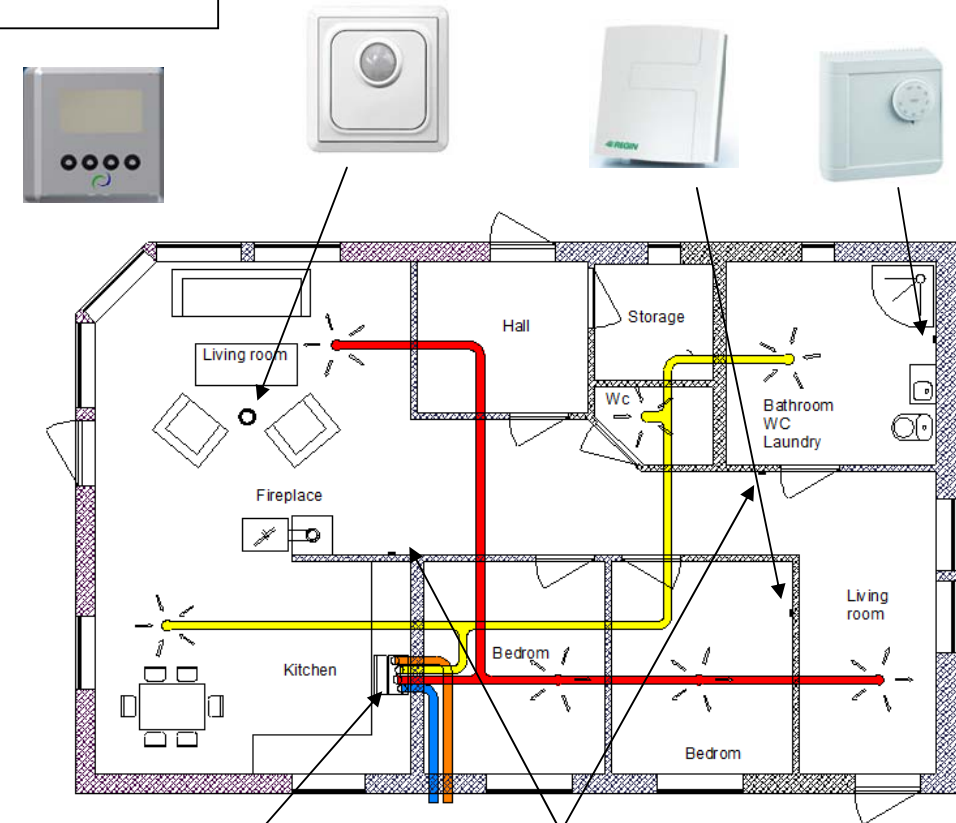

The unit is designed for installation over the stove in the kitchen

Stove / Fireplace / Bathroom

Wireless control panel / pulse switch can be used to increase supply by use of a stove.

Mounted in a suitable location in relation to the unit. Can also be placed near the bathroom for easy operation by forced ventilation (max airflow)

### 3. Connections

#### 3.1 Electrical connections

AHU-200 KV and KH SLIM is supplied with approximately 1.7 m cable and plug for 10A / 230V outlet.

#### Connecting control panel



The control panel comes complete with signal cable, length 10m. The signal cable to the control panel must have at least 10 cm distance to high voltage cables.



The control panel is put into a box and can be attached directly to the wall. Make a suitable hole for the wire in the recess for wire in the box.

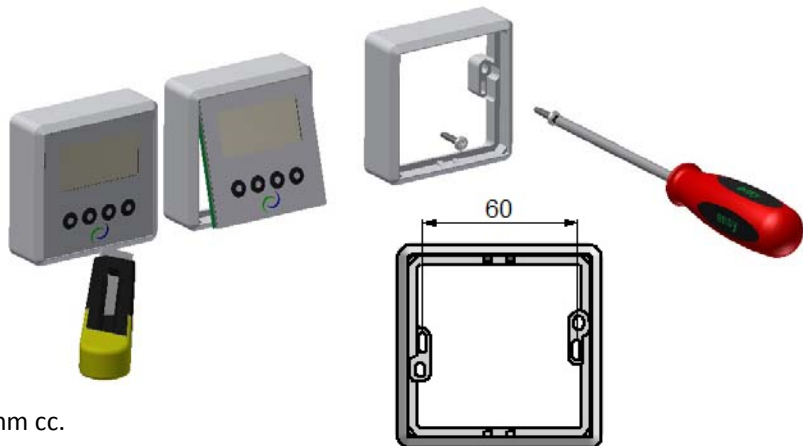

The control panel can also where concealed wiring be attached to standard wall box where the fastening screws in the wall box has 60 mm cc.

In order to dismantle the "touchpad" disc and display this can easily be done by using a knife with thin blade gently inserted between the jacket and the front plate. Then flip the knife down so that the frame loosens.

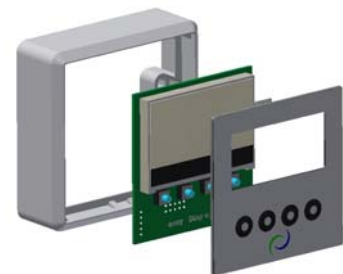

#### Connections of sensors / external functions

See the following wiring diagram for details.

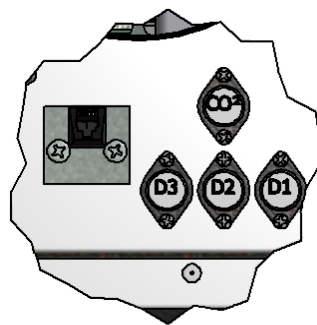

(Sketch shows AHU-200 KV SLIM)

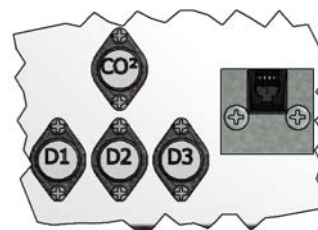

(Sketch shows AHU-200 KH SLIM)



Plugs for connecting external sensors you find in the accessories bag supplied with the unit.

### 3.2 Duct connections

The unit is designed for installation over the stove in the kitchen.

If the unit is mounted on the lightweight wall construction to the living room, for example bedroom / living room, recommended wall insulated / constructed so that the risk of sound transmission avoided.

Fresh air intake is to be placed primarily on the building's north and east and at a good distance from the exhaust openings for ventilation, central vacuum, Hoods and Vents, sewer vent, chimney or other contaminated source such as dust / exhaust from traffic etc. The return of the exhaust air should always be in good distance from fresh air intakes, close windows, etc

#### Sketch for piping.

1. Supply air bedroom
2. Supply air living area
3. Extract kitchen
4. Extract bathroom / utility room
5. Ventilation unit with integrated cooker hood.
6. Roof cowl / exhaust air
7. Fresh air / outdoor air inlet

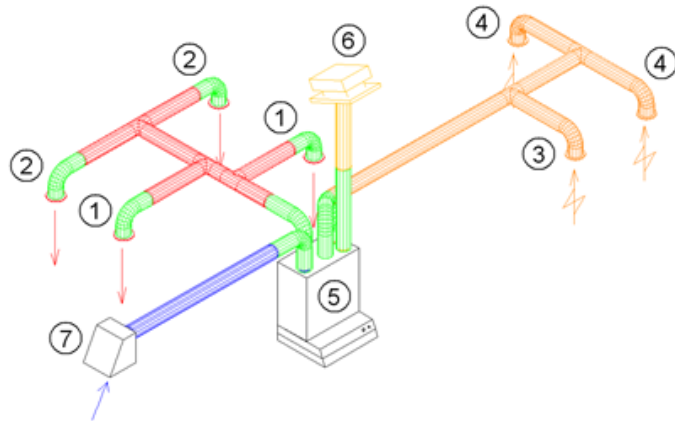

Instead of separate roof cowl for exhaust air and wall grid for fresh air there also can be used combi grids with inlet and outlet air are in the same box.

Find «Intake / exhaust grilles» on [www.ensy.no/Products/Other\\_products\\_accessories/Intake/Exhaust\\_grid\\_with\\_nipple](http://www.ensy.no/Products/Other_products_accessories/Intake/Exhaust_grid_with_nipple)

Find «Combi grid» on [www.ensy.no/ Products/Other\\_products\\_accessories /Kombi grids](http://www.ensy.no/Products/Other_products_accessories/Kombi_grids)

Air to and from the unit will be led through the ducts. Best durability and capabilities for cleaning will be achieved by using ducts in galvanized steel.

Short customizations (à 1 m length) with a flexible aluminum - ducts can be used for piping between the unit and roof cowl / wall grid.

In order to achieve effective, low energy consumption and proper airflow, the duct system designed with low air speeds and low pressure drop.





- ⊠ Tumble dryer must not be connected to the ventilation unit, but have its own duct to the open air.
- ⊠ Duct should be kept covered during storage and installation.
- ⊠ Location of the exhaust grid / roof cowl must also meet current building conditions, as well as any requirements of local building authorities.
- ⊠ All inlet and outlet of the unit must be connected to the piping.

### Pairing of duct sections.

All joints between ducts, T-pipes, bends, reducers, etc. have to be "locked" by using special tape or at least 3 pieces of self-tapping screws.

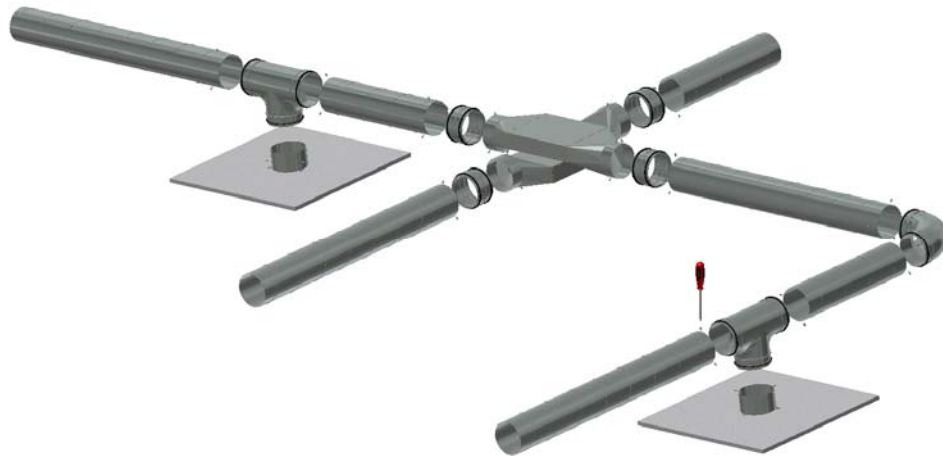

### Sound reduction

To avoid disturbing noise from blowers in living area installation of sound-absorber (silencer) in the duct for supply and extract air recommended. (length = 0.9 meters each section)

To prevent sound transmission between rooms via the duct system, and reduce any noise that occurs in the duct system, is also recommended a silencer in front of each supply diffuser in the living area.

### Flexible ducts.

Flexible ducts can be used for adjustments between the unit and roof cowl / fresh air inlet. Alternatively, the flexible silencers used (remember requirements for outdoor sound level).

## Condensation/isolation

Isolation is necessary to safeguard thermal-, sonic- and fire considerations at the plant. Most often it is a combination of these are due to isolate.

Reasons for thermal insulation of ventilation ducts are:

- obtain good heat economy by limiting heat loss
- achieve a specific outlet temperature of the ventilation air.
- preventing condensation on either the inside or outside of the duct.

Heating costs reduced by preventing the heat supplied in ventilation air can be transferred to unheated surroundings.

If the ducts are positioned in a cold environment, such as in an attic, where the temperature is significantly lower than the ventilation air, there is a risk of condensation inside the ducts. This can be prevented by isolating the channel exterior. In this case, the channel wall being diffusion and would therefore insulate externally with a diffusion material of mineral wool.

It can also be used insulation tubes (100 mm mineral wool) with plastic diffusion barrier pulled over the ducts. The same applies to insulation of pipings between the unit and diffusers, bringing the cooled air up to the rooms.



Note! Remember good overlap of diffusion barrier and tape all joints with duct tape.

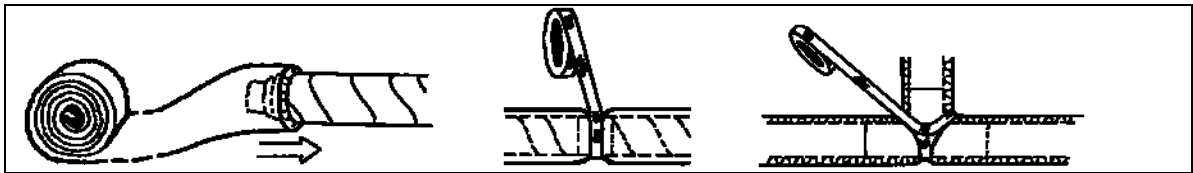

**Fresh air and exhaust duct should always be condensation insulated throughout its length.**

Proper performance of the unit connection is especially important. Similarly, isolate all other ducts for cold and uninsulated room.

In areas with extremely low winter temperatures, additional insulation must be used. Total insulation thickness must be at least 100 mm.

## Inlet diffusers, extract louvers and cooker hood

Supply air diffusers have to be placed in the living area such as bedroom and living room, while the exhaust air louvers are placed in wet areas (bathrooms, laundry, etc.), toilet and kitchen



**NB: Although there is a cooker hood integrated in the unit it also must be mounted separate exhaust louver in the kitchen**

In AHU-200 KH and KV the cooker hood outlet is led directly to the exhaust fan without the smell and pollutants carried through the heat exchanger. In order to achieve heat recovery from ventilation due to exhaust louver in the kitchen, therefore, this exhaust louver has to be connected together with the exhaust from the wet cells.



**NB! The cooker hood is equipped with dampers which are dense in the closed position (without opening for the basic ventilation). If there are any «leakage» in the extract pipe from the cooker hood when the cooker hood isn't activated then there will be a "Rotor fault" alarm.**

Exhaust air louvers can be mounted in the ceiling or wall. Supply air diffuser can be mounted in the ceiling or "low wall". In "low wall" must sectorial aperture positioned so that supply airstream carried upwards along the sloping ceiling. Supply in the wall at the horizontal ceiling must have "throwing direction", so that air enters the room along the ceiling. Air supply via the outlet valve allows air jet throw length, and the exhaust air diffusers can therefore be used as supply air diffuser in the wall when there is ridge ceiling.

The diffusers should be mounted in frames, so that they can be easily removed for cleaning.

### 4 Setting the airflow.

As default setting may supply air diffusers core is opened from 5 to 7 turns from the closed position and locked with a centre nut. Exhaust louvers core is opened 10 turns from the closed position and locked with a centre nut. For adjustment of air flow to each room the settings for the diffusers must be measured. Balancing scheme (diagram) intended by design, or alternatively by balancing acc. flow measurements with equipment specifically designed for this

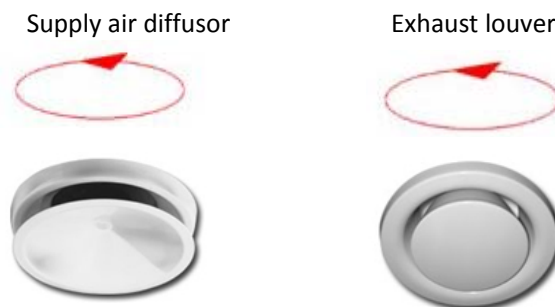
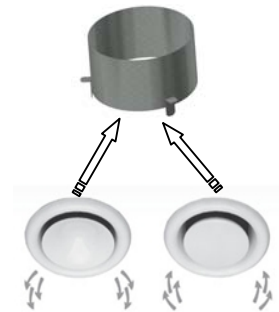

## 5. Alarms

# Alarms on Ensy AHU units

### Critical alarms. Red flashing lights in the control panel

Alarm	Possible causes	Description of what will happend	Reset of alarm
Motor protection <b>Supply</b>	Absence of signal from the fan	EV and RO is turned off. TV and AV turns off after 1 min	Fan turns « <b>OFF</b> » and then back to « <b>NORM</b> »
Motor protection <b>Extract</b>			
Sensor <b>AT</b> open	The sensor is broken.	All functions are deactivated and the unit will stop	Automatic reset after replacement
Sensor <b>OET</b> open			
Overheating	The temperature has exceeded 55°C	Heater (EV) turns off	Automatically when temperature sinking to 25°C (earlier 20°C)
Fire thermostat	Temperature over thermostat exceeded 110°C.	All functions are deactivated and the unit will stop.	Manual reset of the fire thermostat.
Low voltage	Voltage drops below 200 V	All functions are deactivated.	Automatically after voltage rises to 212 V
	No connection from control panel to the master control board.	All functions are deactivated.	Automatically when contact is established again

### Less critical alarms. Yellow flashing lights in the control panel

Alarm	Possible causes	Description of what will happend	Reset of alarm
Sensor <b>EAT</b> open	Short circuit or breach of cable.	All functions are deactivated	Automatic reset after replacement
Sensor <b>AVK</b> open			
Sensor <b>UTE</b> open			
Frost alarm	Supply air from unit is under 5°C. Master card ver.034 or higher is needed for this to be implemented. Display ver.021 or higher is needed to show in the display.	All functions are deactivated	The unit starts up again when supply air temperature has risen to 9°C. The alarm must be manually reset by pressing "enter" (button 4) in the alarm menu.
Filter change	The period of use for the filters is expired	Replace the filters.	See user manual <b>4.3 Filter</b> how to reset alarm

Rotor fault	Efficiency below 20% longer than 2 minutes on mastercard version.023 or lower	Rotor exchanger will stop.	Change dampers or drivebelt if broken.  Fan turns «OFF» and then back to «NORM» to reset
	Efficiency below 20% longer than 10 minutes on mastercard version .024, 030 or 031.		
	Efficiency below 20% longer than 10 hours on mastercard version .033. or higher		

***For more info about alarms and troubleshooting, visit our web site***

***Ensy.no/Service and maintenance/ Alarms on AHU units\_troubleshooting***



If the fans continuing to run when you want to reset an alarm by setting the fans into «OFF» mode then the reason for this is that the **"Weekly schedule"** is activated.

This activation means you do not can put fans in the **"OFF"** position.

What you have to do then is to enter the weekly schedule, scroll until you get to the present day and make that day to be not active by putting a **X** over the active periode. If periode "1" is active then scroll down to "1" and press - (minus) so that it is not active.

Then you can go back in the menu and set the fans in **"OFF"** position to reset the alarm.

Remember to go back into the weekly schedule and set the period "1" active again by pressing the **+** button.

Press button 4 to accept the changes. Then press button 1 two times to get to the start side again.

**Rotor Fault alarm will not be activated if:**



1. When using the kitchen hood.
2. If the difference between UTE (Fresh air temperature sensor) and EAT (Extract temperature sensor) is less than +/- 5°C
3. When the extract air fan stops. (Rotory exchanger will always stop when the supply air fan stops.)



When troubleshooting.

1. On the master card there is a small yellow diode light. This should be in normal operation flashing approximately once per second.
2. If this light stays on all the time without blinking then the card stalled. What you can try is to unplug and plug in again and see if this helps. Whether there are still lit all the time then a reprogramming the software on the master card is what is needed to be done. To reprogram then you have to contact your service partner. Reprogram then to version 034 or newer/higher if it is posted on Ensy.no.
3. If the light is blinking faster than once per second than do the same procedure here as above in section. 2.



**Ensy AS**  
Mohagasvingen 1  
N-2770 JAREN  
<http://www.ensy.no>